

# NEA - ICU

Monitoring system for emergency power systems



# INOTEC Sicherheitstechnik GmbH Innovative Emergency Lighting Technology



INOTEC Sicherheitstechnik GmbH is an innovative medium-sized company in Ense-Höingen, Westphalia with its own R&D department, production and a national and international sales and distribution.

A competent team ensures the reliable support in all questions concerning products, planning, service and standards with flexible and committed employees.

Since the foundation in 1995 INOTEC Sicherheitstechnik GmbH developed into a globally operating company with more than 230 employees. Additional jobs were created with the numerous partners within Europe and Middle East.

The production and administration area increased in Germany up to 14,000m<sup>2</sup>.

Nowadays INOTEC Sicherheitstechnik GmbH is one of the leading producers of emergency and safety lightings. Modern, technical advanced products, "Made in Germany", are setting new global standards such as the JOKER technology for emergency lighting systems or Dynamic Escape Routing (D.E.R.).

©Copyright: INOTEC Sicherheitstechnik GmbH, Ense  
Publications and copies, even partial, only with  
manufacturers permission.

Subject to technical changes.

The emergency lighting systems presented in the  
catalogue are not compatible with the monitoring  
systems type INOTEC SVPC, SV-Central or Multifunc-  
tion Controller.

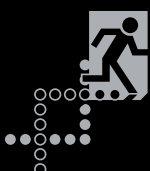

# Made in Germany

## Quality from a single source

With INOTEC you obtain everything about emergency lighting from a single source and also "Made in Germany". Besides the development and design we also engage ourselves with the production at the industrial location Germany. To meet our high requirements and our customers one's, we rely on:

- Customer-oriented development
- Latest technologies
- Continuous optimisation and further development of our products
- Competent supplier

Our products stand for safety and this is one of our most important quality characteristics. Also INOTEC is known for its innovative luminaire design and high quality workmanship.

Due to the high responsibility of our products, quality control has high priority for INOTEC. We guarantee optimum safety and durable, efficient functionality of our products because of the intensive quality management.



## Content

<b>Emergency power system NEA</b>	4
<b>NEA-ICU</b>	5
<b>Functions and features</b>	6 - 7
<b>Individual luminaire monitoring</b>	8
<b>Circuit monitoring</b>	9
<b>INOView - Centralised monitoring</b>	10 - 11
<b>INOWeb - Monitoring via web browser</b>	12
<b>Configuration Software</b>	13
<b>System components and options</b>	14 - 23

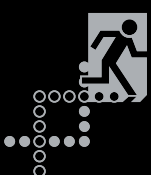

# Emergency power system NEA

For safety lighting purposes (Diesel-) generators or a second grid feed (AC) of the energy supplier are allowed next to battery-supported systems according to DIN VDE 0100-560. But in this case the inspection requirements according to DIN EN 50172 as well as DIN V VDE V 0108-100 need to be fulfilled. This can be done manually, but for larger installations it does involve higher time exposure and costs.

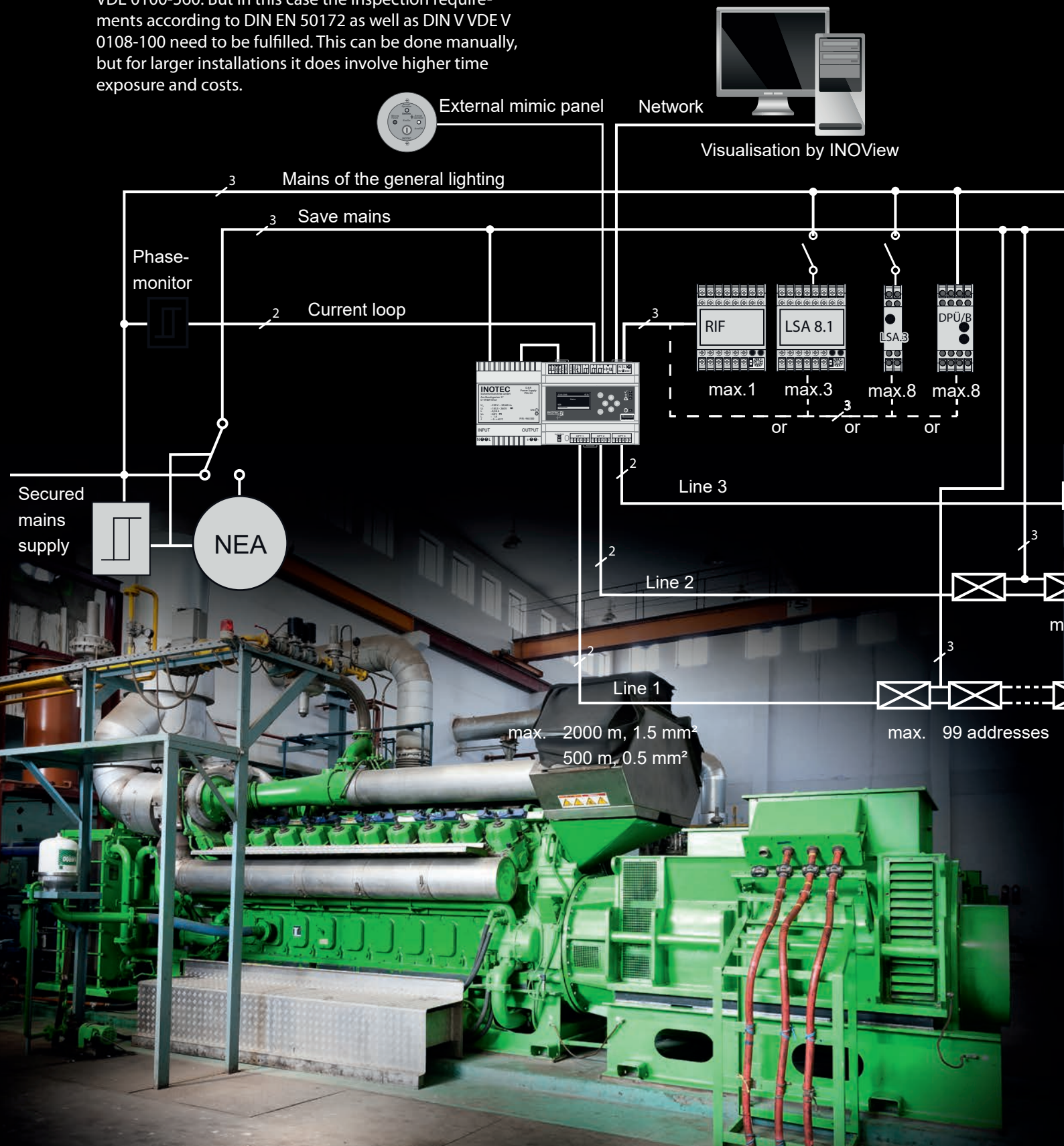

# NEA-ICU

When you use the INOTEC Controller Unit for emergency power systems (NEA-ICU) as an automatic testing system for safety lighting, the recurring maintenance effort decreases significantly. The results of all performed tests are recorded in detail in the integrated logbook.



The installation of the emergency generating system for safety lighting purposes has to be done according to DIN VDE 0100-560. Thereby up to 20 luminaires per circuit need to be secured accordingly in a fire compartment. At the controller more luminaires can be monitored via BUS connection as far as the safety in case of a failure of the controller is still secured. Thus up to 99 luminaires (in total up to 297 luminaires) can be tested according to their function and monitored per option slot.

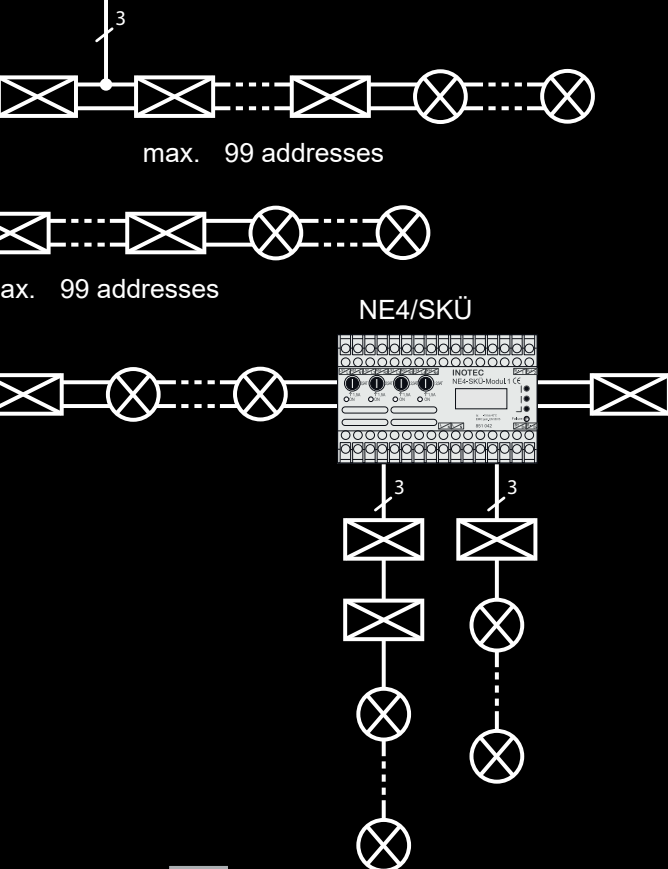

In this process the NEA ICU system supports the free allocation of the operation modes (maintained-, switched-maintained and non-maintained) for each luminaire in the circuit. And this can be configured centrally without a change in luminaires. This does not only lead to a significant reduction of final circuits, but also the cabling, installation effort, fire load and costs are minimised.

## Functions and features



The NEA-ICU tests, monitors and controls the safety lighting units with emergency power supply automatically according to DIN VDE 0100-560 and DIN EN 50172. It can be installed easily in a space-saving DIN-rail housing with a wide of 6 space units in the sub-db of the safety lighting.

Three slots enable the reliable monitoring and control of up to 297 luminaires via 2-core insensitive BUS-line. The system, which is focussing on safety, switches into the safety mode independently in case of an interruption of the BUS-line => All luminaires ON .

On the graphical OLED-display detailed status information of the controller and the monitored luminaires with location texts are intuitively accessible. The data can be saved comfortably for external processing via integrated USB port. Via PC-software, which is available free of charge, the controller can be configured.

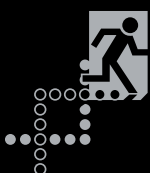
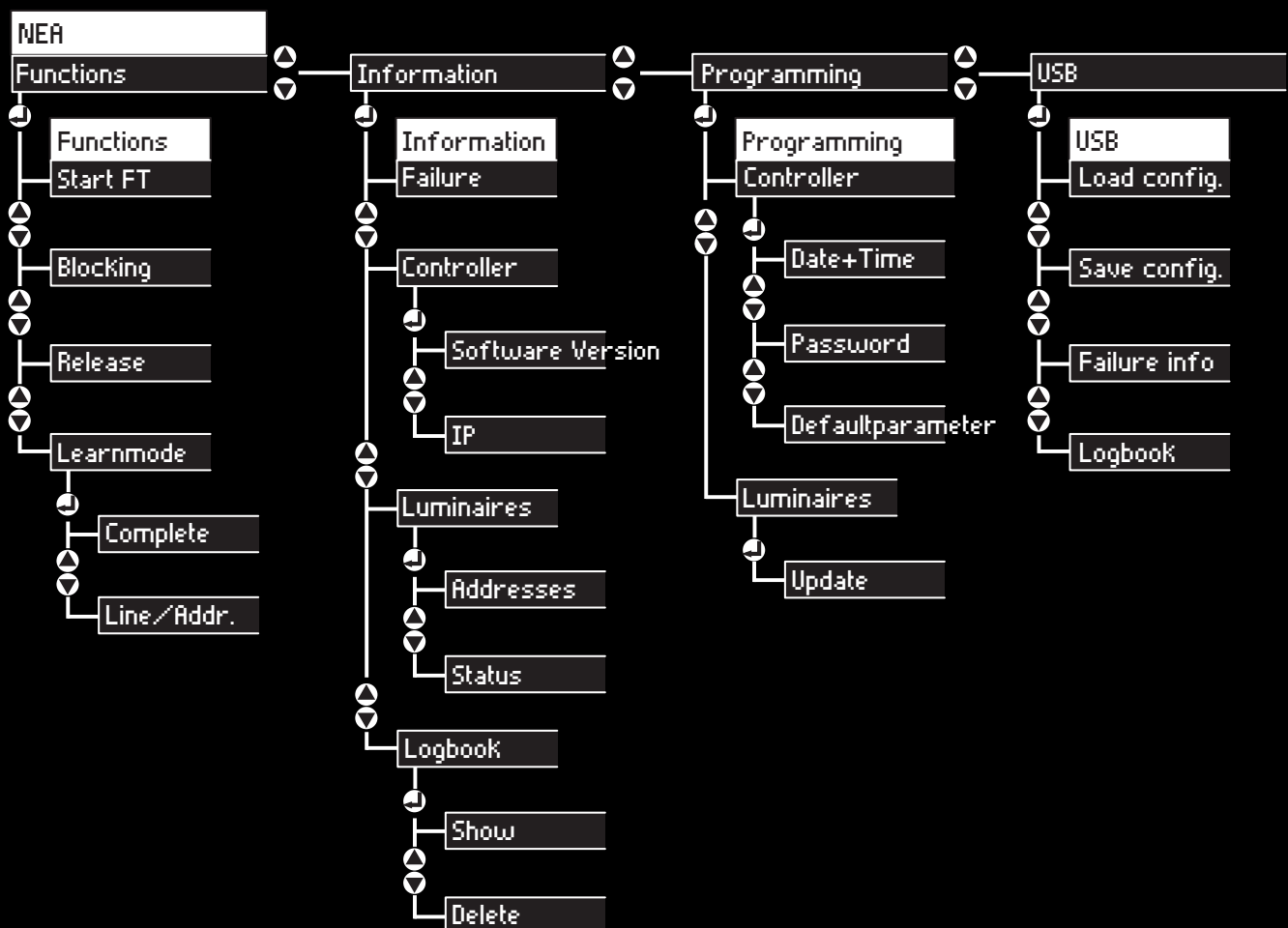

# Functions and features

The operation mode (Maintained-, non-maintained- and switched-maintained- operation) for each luminaire needs to be defined in the PC-software.

Two switch inputs are allocatable per luminaire. The programming can also be done later without any changes at the luminaires.

Via integrated current loop the mains supply of the general lighting is monitored and in case of a power failure all luminaires are switched on.

By use of the remote switch input the maintained luminaires can be switched off during shutdown times.

Both inputs can be monitored for short circuit in case of a fire for increased safety. The system will switch into the safe mode independently.

A connection to the central monitoring software INOView is possible via integrated network connection or optionally via 3-core RTG-BUS-connection.

Also the status of the luminaires is accessible by web-browser via network interface.

- ▶ Graphical OLED-Display
- ▶ USB-interface
- ▶ Network interface
- ▶ Remote switch input
- ▶ Three slots to monitor 99 luminaires each
- ▶ Internal BUS to connect to relais interface, light switch module or 3-phase monitoring relay
- ▶ Integrated logbook
- ▶ Integrated webserver
- ▶ Automatical test mode
- ▶ Potential free sum failure contact
- ▶ LSA 3, LSA 8 or DPÜ/B to switch luminaires connectable

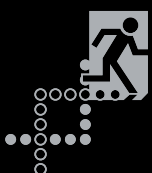
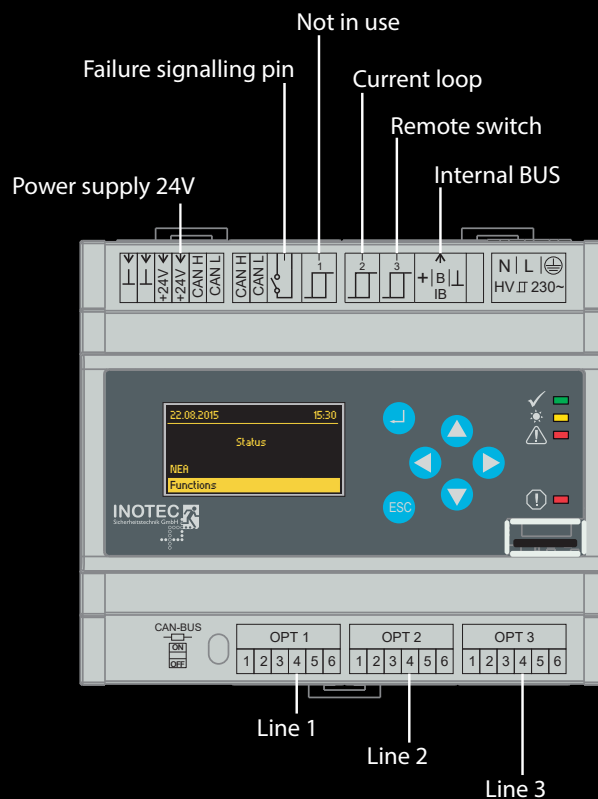

# Individual luminaire monitoring (SV)

The emergency and safety luminaires supplied by emergency power units are controlled and monitored via NEA-ICU controller and NE-ET-SV, NE-SV-EVGs and NE-SV/S-modules. A 2-core, non-shielded data line, for example YR 2 x 0.8 mm, is installed from each option slot to the max. 99 luminaires to control and monitor.

The operating modes maintained lighting, non-maintained lighting, switched maintained lighting can be programmed without a change in luminaires and can be modified later by adjusting the configuration. Due to the constant BUS-communication the maintained luminaires are monitored permanently!

Every luminaire can either be switched centrally via a switching allocation with the general lighting or via sense-input at the module. Therefore the switched phase and the neutral conductor need to be connected to the corresponding LS/NS-inputs at the module.

Regardless of the switching status of the luminaires they are switched on in case of a power failure, a BUS-failure or a BUS interruption!

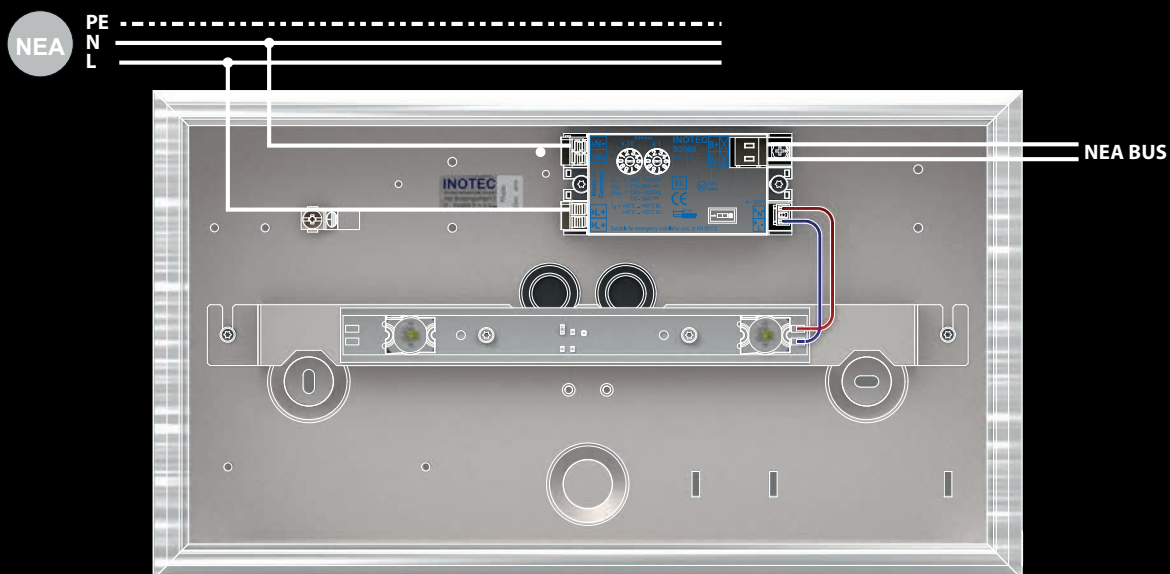



# Circuit monitoring (SKÜ)

Using the NE4-SKÜ modules, which exist in two versions, the luminaires can be controlled by 4 AC-circuits and monitored via current measurement. Next to the standard module with 4 outputs for 1.5A, a version with 2 circuits for 1.5A and 2 circuits for 0.3A is available.

The operating mode of each circuit as well as the deviation of the nominal value can be specified individually. The settings are also directly adjustable at the NE4-SKÜ module. The four circuits are assigned with one address only to the databus.

In the DIN rail housing of the NE4-SKÜ-module a light switch input for each circuit is integrated for switching together with the general lighting. Also a current loop input exists to monitor the sub-distribution board of the general lighting. In case of a failure of the sub-db the four circuits are switched on.



**The maintained lighting circuits are also monitored by the circuit monitoring permanently!**

**In case of a failure of the BUS-communication the modules switch on the circuits regardless of the operating mode!**

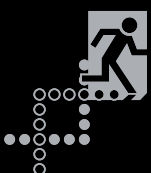
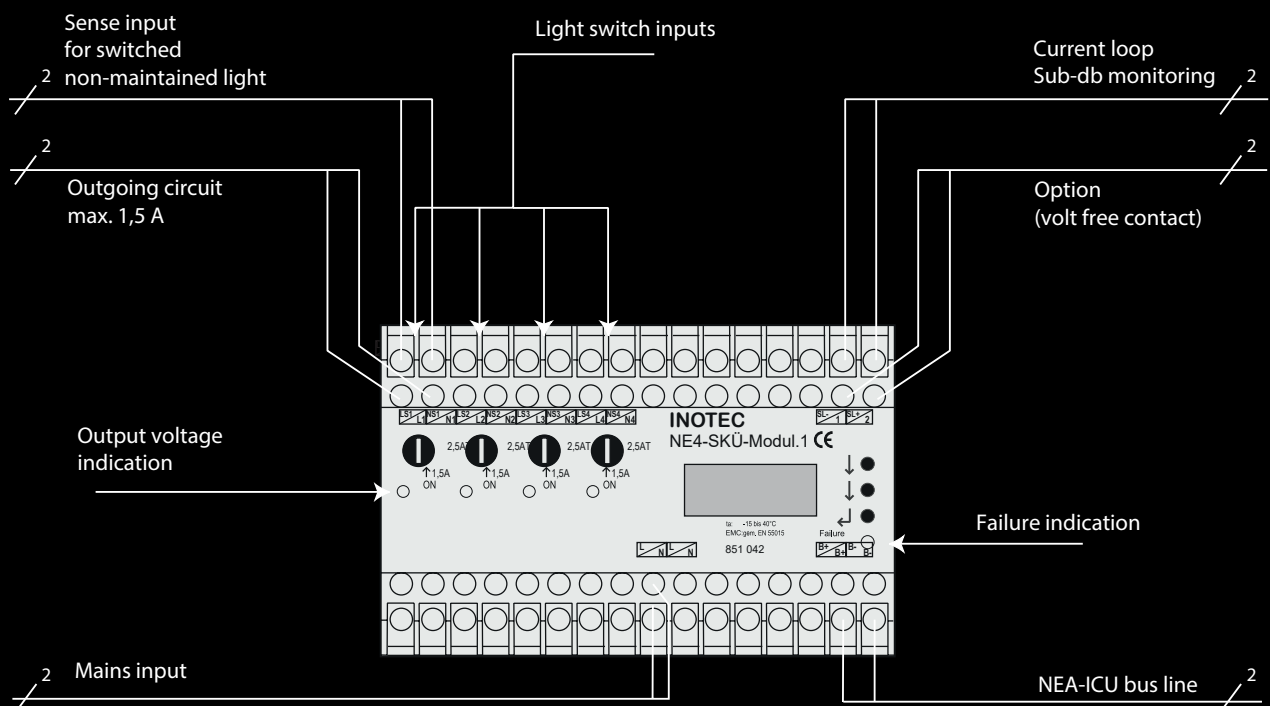

# INOView - Centralised monitoring

The central monitoring software INOView displays the status of the NEA-ICU-system clearly arranged at a central position. Due to the modern and self-explanatory software failures can be localised quickly in the system. By double-clicking in the dialogue device the related detail view error is shown. For a greater clarity several detail views can be opened in parallel.

An integrated logbook records all changes in status and test results at a central position. The proper function of the system is demonstrable at any time.

All INOTEC emergency lighting systems can be monitored with the INOView-software in one application via

three-core RTG-BUS or network connection. Via integrated user administration the relevant rights can be assigned to each user.

Staff members can be informed quickly about failures via email-function and are able to react immediately.

The screenshot shows the INOView software interface. The top menu bar includes 'INOTEC', 'Functions', 'View', 'Floor plan view', and 'Debug'. Below the menu is a toolbar with various icons for system tests, block release, manual reset, logbook, device failures, controller settings, login/logout, user administration, BCS view, settings, and help. The main area is divided into a left sidebar with a tree view and a central main panel. The tree view shows a hierarchy: Project > Produktmanagement Group > NEA-ICU > Controller > Line > Luminaire Container > LAGER1 (1 - NEA member), Lager 2 (2 - NEA member), Lager 3 (3 - NEA member), Lager 4 (4 - NEA member). The main panel displays the 'General' and 'Status' tabs for the selected NEA-ICU device. It shows a device type 'NEA', a destination, and a 'Total status' of 'Operation'. Below this, there are columns for 'Communication, last connection', 'Last functiontest', and 'Last successful configuration download'. A context menu is open over the 'LAGER1' device, listing options like 'Start functiontest', 'Delete', 'Device monitor', 'Load configuration of device from controller', 'Load configuration from configuration file', 'Konfiguration des Geräts mit Konfigurator erstellen/bearbeiten', and 'Settings dialog'. At the bottom, there is a table titled 'Devices with noticeable status'.

Type	Destination	Status
NEA		Configuration failure
CLS24	PM CLS 24	Offline
CPS220/64	PM CPS 220-64	Sub-DB failure
CPS220/64	CPS 64 - Verwaltung Neubau	Failure
CLS24	Geräetefertigung	Offline
CLS24		Offline

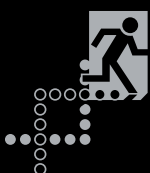

# Floor plan visualisation incl. status display

The localisation of luminaires within the project is simplified due to the optional floor plan module. You can zoom and move the floor plan data files, which are based on vectors, continuously. It's possible to import data from common CAD systems.

Luminaires can be placed into the floor plan via drag & drop. For a better visualisation the luminaire types - emergency signs - or safety lighting - can be defined freely and common arrow direction can be adjusted.

Additionally the status (mode, failure, etc.) of each luminaire is displayed in the floor plan in colour.

The screenshot shows the INOTEC software interface. On the left is a project tree with categories like 'Project', 'Functions', 'Produktmanagement Group', 'NEA-ICU', 'Controller', 'Line', 'Luminaire Container', 'Switching modules', and 'NEA'. The main window displays a floor plan with several green circular icons representing luminaires. Overlaid on the floor plan are three logbook windows. The top logbook window shows a table of events with columns for Date, Time, Device, Device destination, Group destination, Port, and Event. The middle logbook window shows a detailed view of an event, including device and group information. The bottom logbook window shows another detailed view of an event, including device and group information.

Clearly arranged logbook display with filter function. These can be sorted freely in the chart. It's also possible to get a printable version. The entries in the charts can be arranged and filtered based on the existing columns several times. For example the entries can be arranged according to the destination of the device and event. Thus a simplified failure analysis is possible. Additional information can be opened via detail view. Individual luminaire failures are displayed up to destination level and can be displayed on a printer.

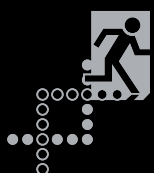

# INOWeb - Monitoring via web browser

The NEA-ICU includes an integrated web server. With this the states can be recalled at any time via web browser using a computer, tablet or smartphone. With the corresponding network configuration an access via intra-/internet is possible from anywhere. The overall status of the controller and each luminaire is displayed clearly in the web representation.

A start of the function test or the blocking/releasing of the NEA-ICU is possible from the web interface. You can scan the QR code and test the web interface of the NEA-ICU.



<http://neademo.ense.inotec-licht.de>

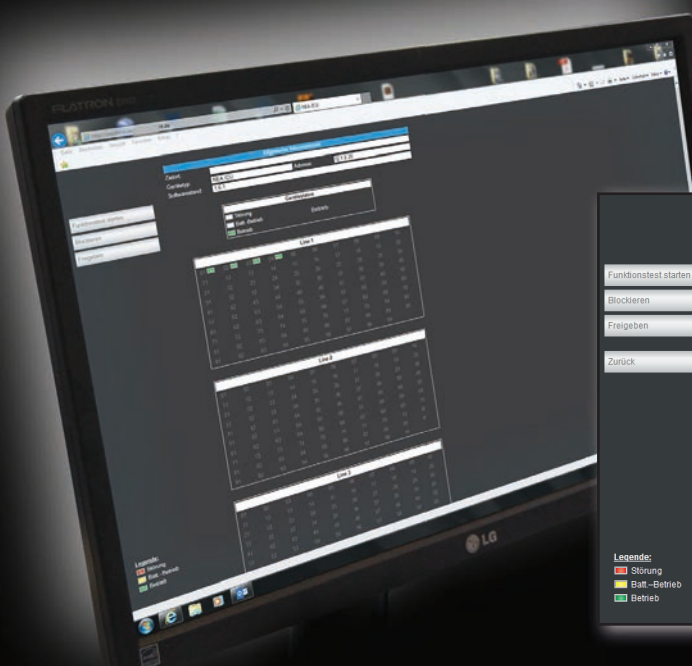
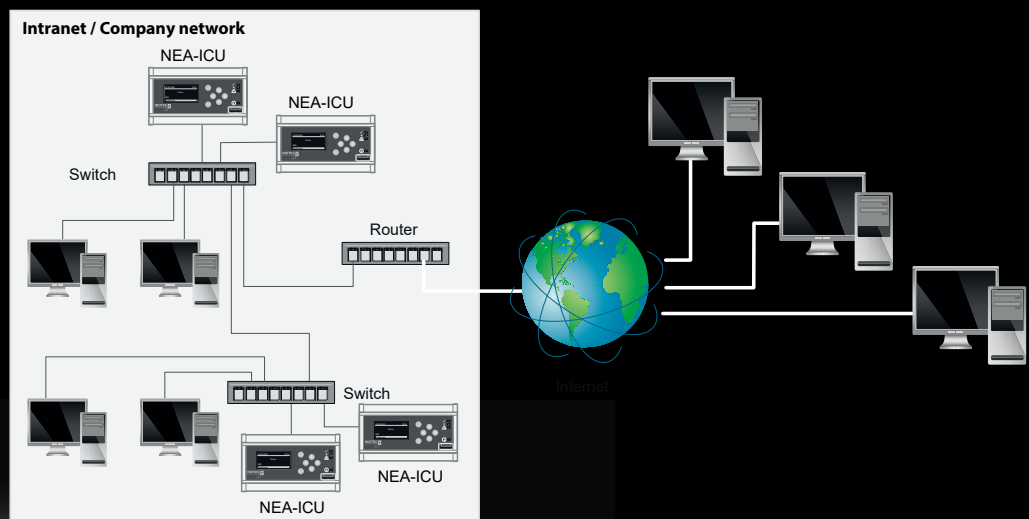

Allgemeine Informationen	
Zielort:	
Gerätetyp:	NEA-ICU
Adresse:	10.1.8.28
Softwarestand:	1.6.1

Leuchteninformation	
Zielort:	
Leuchte:	Line: 1 Adr: 2

Leuchtenstatus	
<input type="checkbox"/> Störung	
<input type="checkbox"/> Stör-Betrieb	
<input checked="" type="checkbox"/> Betrieb	Betrieb

  

Legende:  
 Störung  
 Stör-Betrieb  
 Betrieb

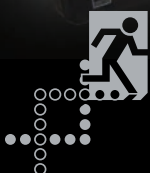

# Configurator software

The configuration of the NEA-ICU controller works with the corresponding computer software and is transferred to the controller via USB-port or network connection. All settings of the controller can be applied at the computer software.

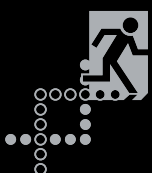
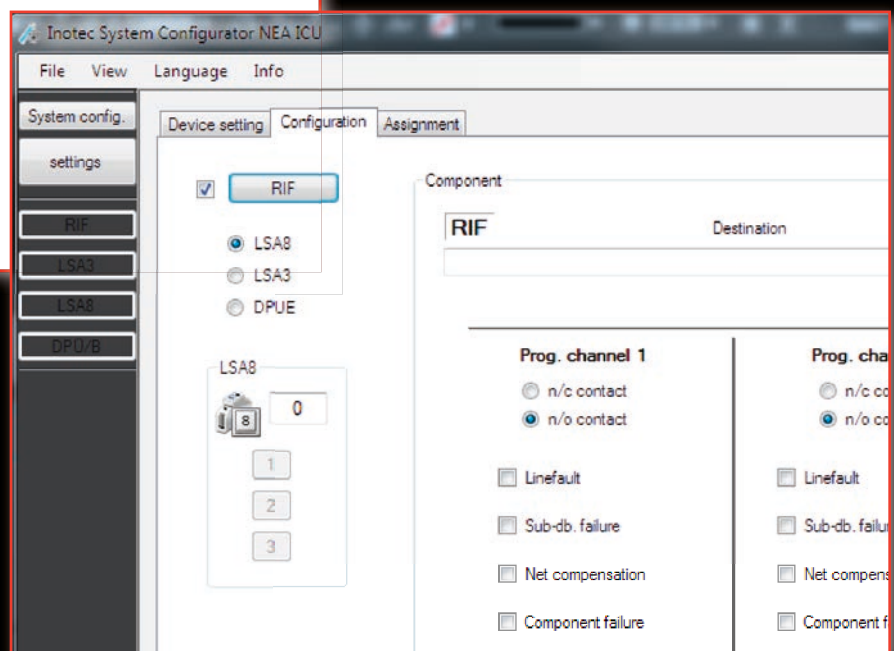
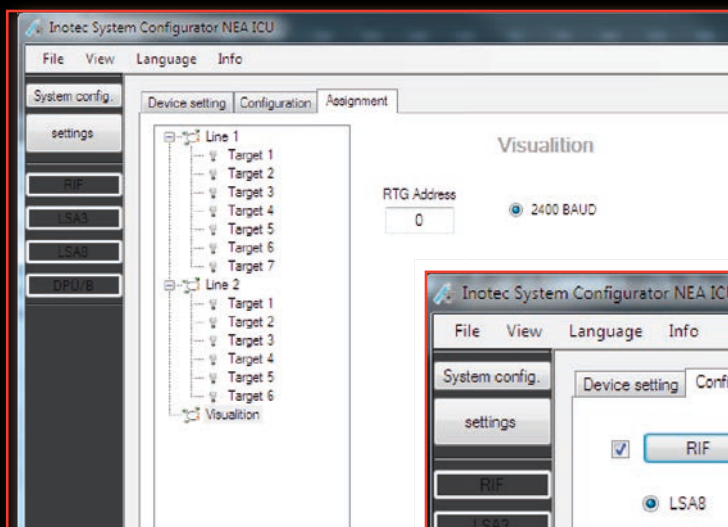
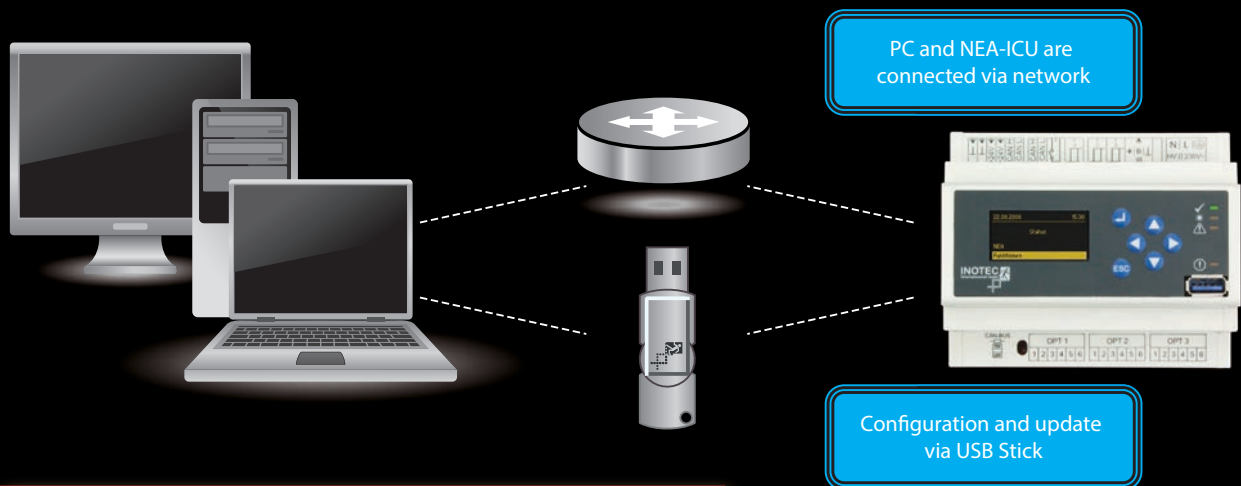

Fully automated, microprocessor controlled monitoring and testing facility with Ethernet- and USB interface for emergency power systems.

3 cards with up to 99 addresses insertable each.

Operating modes such as maintained-, switched-maintained and non-maintained operation freely programmable for each luminaire.

Automatic function test, points in time freely selectable.

Connection possibility of three-phase monitoring relay, light switch module or the Relais-Interface-module.

Displaying the operating states up to luminaire level with localisation.

Integrated logbook acc. to EN 50172 for recording more than 4 years with detail information.

Integrated USB port to save failures and logbook as well as to upload the device configuration. Visualisation possibility INOView or INOWeb via installed ethernet interface.

Optional RTG-interface to communicate with the visualisation software INOView.

### NEA-ICU

Art. No. 869 015 V

### Monitoring system

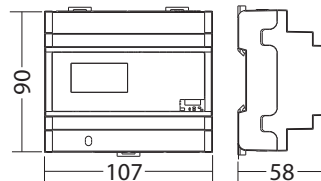

### Technical data

<b>Housing material:</b>	Thermoplastic V0
<b>Nominal voltage:</b>	24V DC +/- 20%
<b>Protection class:</b>	III
<b>Protection category:</b>	IP 20
<b>Amb. temp. range:</b>	-15°C ... +40°C
<b>EMC protection:</b>	acc. to EN 61000-6-2 / 61000-6-3
<b>Conductor connection:</b>	2.5mm <sup>2</sup> single core or 1.5mm <sup>2</sup> braid wire with cable sleeve

Small distribution board to install NEA-ICU as well as other system components. Versions as surface-, flush mounted-, recessed wall- and IP65 distributor cover all mounting styles. Depending on the number of components, which need to be installed, the distributors are available in the version with 2-row up to 3 rows. The 2-row small distribution board has 6 usable Division units (SU) on the first rail. The remaining space is occupied by the output terminals. The 3-row small distribution board has 12 more Division units (SU) available.

### NEA - ICU - surface mounted

Art. No. 869 016V

### NEA - ICU - flush mounted

Art. No. 869 017V

### NEA - ICU - recessed wall

Art. No. 869 018V

### NEA - ICU - IP65

Art. No. 869 019V

### NEA-ICU in a cabinet

2-row to 3-row

2-row to 3-row

2-row to 3-row

2-row to 3-row



Regulated power supply with power indicator and overload display by LED.

Output galvanically isolated according to EN 60950 (safety extra-low voltage).

Suitable for mounting on DIN rails.

**PSU 24 / 1,3A**

Art. No. 146 048

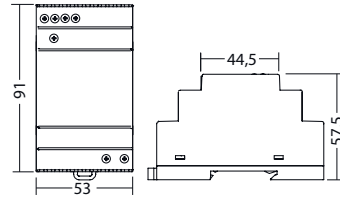
**Supply unit**

**Technical data**

<b>Housing material:</b>	Thermoplastic V0
<b>Nominal voltage:</b>	230 V +/- 15% AC, 184V - 260V DC
<b>Nominal current I<sub>N</sub>:</b>	0.4A
<b>Output voltage:</b>	24V
<b>Output current:</b>	1.3A
<b>Overload capacity:</b>	Sustained short circuit proof
<b>Amb. temp. range:</b>	-20°C ... +55°C
<b>Protection category:</b>	IP20 (terminal)
<b>Protection class:</b>	II
<b>EMC protection:</b>	acc. to EN 61000-6-2 / 61000-6-3
<b>Conductor connection:</b>	screw terminal 0.2 ... 2.5mm <sup>2</sup>



Relay interface to display status reports externally.  
5 volt free signal contacts for

- Operation
- Test reports or power failure
- Failure (general)
- Freely programmable 2x

### Technical data

**Housing material:** Thermoplastic V0  
**Nominal voltage:** 230V 50Hz / 60Hz  
**Protection category:** IP20  
**Amb. temp. range:** -15°C ... +40°C  
**EMC protection:** acc. to EN 61000-6-2 / 61000-6-3  
**Conductor connection** 2.5mm<sup>2</sup> single core or 1.5mm<sup>2</sup> braid wire with cable sleeve

Relay contacts	System status	Operation	Failure	Emergency power operation
	Failure (1-2)	closed	open	open
Operation (3-4)	closed	open	open	open
Em. oper.* (5-6)	open	open	open	closed
Option 1	freely programmable			
Option 2	freely programmable			

\* equal to emergency power operation

### RIF 5

Art. No. 850 009

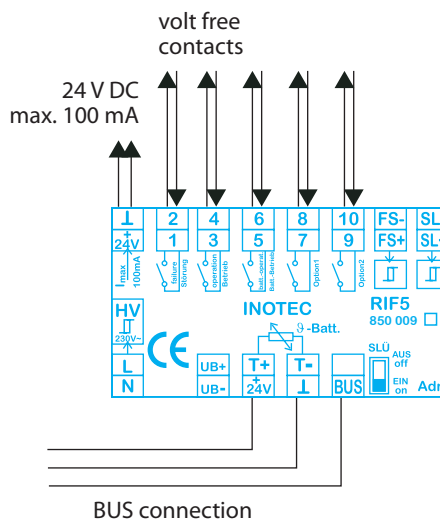
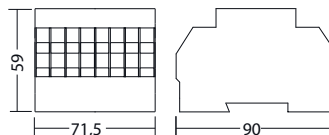



For voltage monitoring of sub-distribution boards of the general lighting.

With volt free signalling contact / 1 changeover contact

- LED-display for L1, L2, L3
- optional phase sequence
- detection of undervoltage and power failure in the three-phase supply
- also connectable 1-phase acc. to IEC 255, VDE 0435, T.303
- for DIN rail mounting

#### Technical data

<b>Housing material:</b>	Thermoplastic V0
<b>Nominal voltage:</b>	230V/400V AC 50Hz / 60Hz,
<b>Response value:</b>	0.85 $U_N$
<b>Protection class:</b>	II
<b>Protection category:</b>	IP20
<b>Amb. temp. range:</b>	-20°C ... +40°C
<b>EMC protection:</b>	acc. to EN 61000-6-2 / 61000-6-3
<b>Conductor connection:</b>	2.5mm <sup>2</sup> single core or 1.5mm <sup>2</sup> braid wire with cable sleeve

For voltage monitoring of the sub-distribution boards of the general lighting. Including a detailed phase failure display and the location text in the controller in plain text.

With volt free signalling contact / 2 normally open contacts

- LED-display for L1, L2, L3
- optimal phase sequence
- detection of undervoltage and power failure in the three-phase supply
- also connectable 1-phase acc. to IEC 255, VDE 0435, T.303
- suitable for mounting on DIN rail
- detailed display of the phase failure with localisation of the sub-db in plain text
- adjustable follow-up time after power recover

Max. 8 DPÜ/B.2 modules can be connected to one controller!

#### Technical data

<b>Housing material:</b>	Thermoplastic V0
<b>Nominal voltage:</b>	230V / 400V AC 50Hz / 60Hz,
<b>Response value:</b>	0.85 $U_N$
<b>Protection class:</b>	II
<b>Protection category:</b>	IP20
<b>Amb. temp. range:</b>	-15 °C ... +40 °C
<b>EMC protection:</b>	acc. to EN 61000-6-2 / 61000-6-3
<b>Conductor connection:</b>	2.5mm <sup>2</sup> single core or 1.5mm <sup>2</sup> braid wire with cable sleeve

#### DPÜ

Art. No. 890 400

#### 3-phase monitoring relay

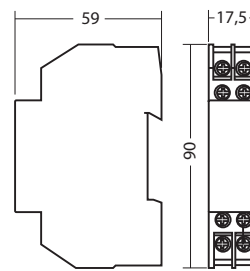

#### DPÜ/B.2

Art. No. 890 417

#### 3-phase monitoring relay BUS

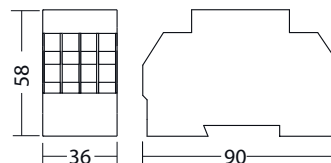

For a joint switching of mains- and safety- luminaires and to monitor the voltage.

The channels are galvanically isolated.

The allocation of the luminaires to the light switch modules is done during the programming of the controller.

3-phase monitoring/ BUS

- optional phase sequence
- Signal contact / 1 change-over contact
- detection of undervoltage and mains failure
- also connectable 1-phase acc. to IEC 255, VDE 0435, T.303
- nominal voltage 230V / 400V AC
- response value  $0.85 U_N$
- may be switched off

Max. 3 LSA 8.1 modules can be connected to a controller!

The three-phase monitoring has no function at the NEA-ICU!

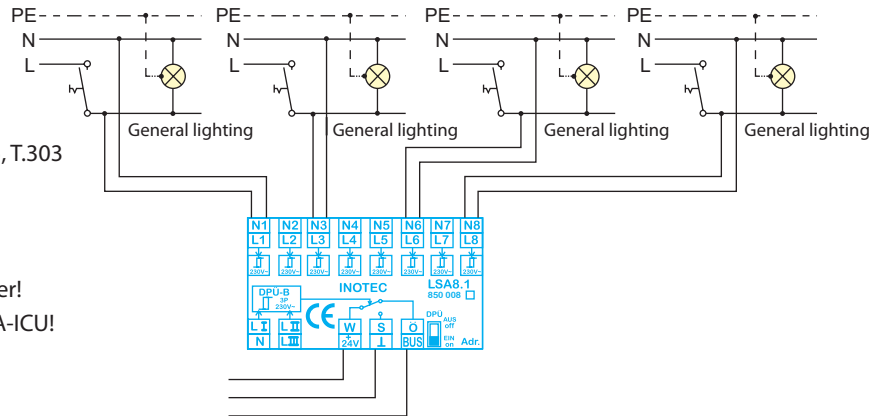

BUS- connection

### Technical data

- Housing material:** Thermoplastic V0  
**Nominal voltage:** 230V AC  
**Protection class:** II  
**Protection category:** IP20  
**Amb. temp. range:** -15°C ... +40°C  
**EMC protection:** acc. to EN 61000-6-2 / 61000-6-3  
**Conductor connection:** 2.5mm<sup>2</sup> single core or 1.5mm<sup>2</sup> braid wire with cable sleeve

### LSA 8.1 / 230V

Art. No. 850 008

### Light switch module, 8 channels

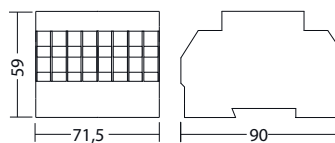

### Technical data

- Housing material:** Thermoplastic V0  
**Nominal voltage:** 24V DC  
**Protection class:** II  
**Protection category:** IP20  
**Amb. temp. range:** -15°C ... +40°C  
**EMC protection:** acc. to EN 61000-6-2 / 61000-6-3  
**Conductor connection:** 2.5mm<sup>2</sup> single core or 1.5mm<sup>2</sup> braid wire with cable sleeve

### LSA 8.1 / 24V

Art. No. 850 007

### Light switch module, 8 channels

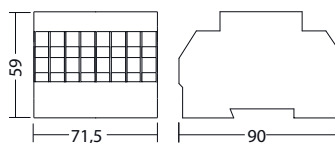

### Technical data

- Housing material:** Thermoplastic V0  
**Nominal voltage:** 230V AC  
**Protection class:** II  
**Protection category:** IP 20  
**Amb. temp. range:** -15 °C ... +40 °C  
**EMC protection:** acc. to EN 61000-6-2 / 61000-6-3  
**Conductor connection:** 2.5mm<sup>2</sup> single core or 1.5mm<sup>2</sup> braid wire with cable sleeve

### LSA 3.1 / 230V

Art. No. 850 010

### Light switch module, 3 channels

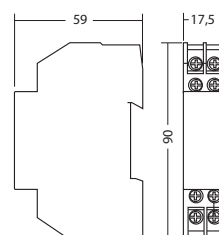

**Circuit monitoring module for external installation**

To monitor and control 4 AC circuits. To connect to emergency power systems in combination with INOTEC NEA-ICU via 2-core, non-shielded line.

**Monitoring functions:**

The operation mode as well as the percentage value of the max. deviation per circuit can be determined individually.

Optional constant circuit monitoring when the circuit is switched on.

- red LEDs displaying failures
- yellow LEDs to display the output voltage
- with 24V current loop

One light switch query per circuit for a joint switching of the safety luminaires with the general lighting.

Not suitable for KVG- luminaires!

**4 circuits with a max. connected current of 1.5A each.**
**Technical data**

<b>Housing material:</b>	Thermoplastic V0
<b>Nominal voltage:</b>	230V AC $\pm$ 10 %, 50Hz / 60 Hz
<b>Output current:</b>	4x1.5A
<b>Inrush current:</b>	max. 80A / 50 $\mu$ s
<b>Protection class:</b>	II
<b>Protection category:</b>	IP 20
<b>Amb. temp. range:</b>	-15°C ... +40°C
<b>EMC protection:</b>	acc. to EN 55015
<b>Conductor connection:</b>	2.5mm <sup>2</sup> single core or 1.5mm <sup>2</sup> braid wire with cable sleeve

**NE4-SKÜ.1**

Art. No. 851 042

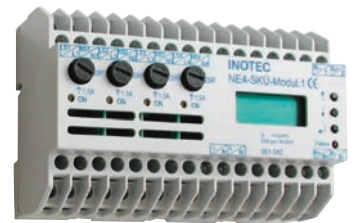
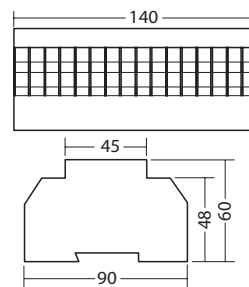
**Circuit monitoring module**

**2 circuits with a max. current of 1.5 A and 2 circuits with 300mA.**
**Technical data**

<b>Housing material:</b>	Thermoplastic V0
<b>Nominal voltage:</b>	230V AC, $\pm$ 10 %, 50Hz / 60Hz
<b>Output current:</b>	2x1.5A, 2x300mA
<b>Inrush current:</b>	max. 80A / 50 $\mu$ s
<b>Protection class:</b>	II
<b>Protection category:</b>	IP 20
<b>Amb. temp. range:</b>	-15°C ... +40°C
<b>EMC protection:</b>	acc. to EN 55015
<b>Conductor connection:</b>	2.5mm <sup>2</sup> single core or 1.5mm <sup>2</sup> braid wire with cable sleeve

**NE4/2-SKÜ.1**

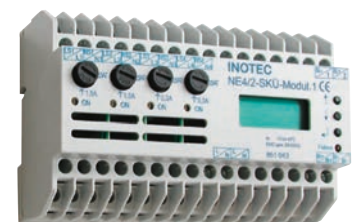
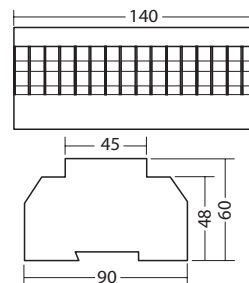
Art. No. 851 043

**Circuit monitoring module**

LED-driver for emergency power units to supply 1-6 LEDs.  
 For connection to INOTEC NEA-ICU. With integrated LED-  
 monitoring. Dimmable in mains operation from 0% to 100%  
 in emergency operation 100%.

Intended for installation in luminaires.

#### Technical data

<b>Housing material:</b>	Thermoplastic V0
<b>Nominal voltage:</b>	230V 50Hz / 60Hz AC
	176V - 264V DC
<b>Output voltage:</b>	max. 24V DC (SELV equivalent)
<b>Output current:</b>	320mA constant
<b>cos φ:</b>	0.6 ... 0.77
<b>Amb. temp. range:</b>	-15°C ... +45°C
<b>Inrush current:</b>	8A/50μs
<b>EMC protection:</b>	acc. to EN 55015
<b>Conductor connection:</b>	2.5mm <sup>2</sup> single core or 1.5mm <sup>2</sup> braid wire with cable sleeve depending on terminal type 2-pole pin header for LED

#### NE-ET 9/24

Art. No. 860 014

#### LED-driver

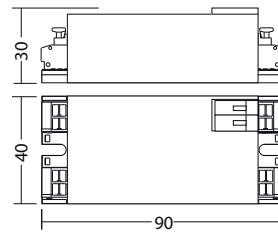

Module for the single luminaire monitoring of LLp, AGL and halogen lamps, 5W - 120W, with address switch for luminaire coding. With light switch input, that means luminaires with these NE-SV-monitoring modules can be switched together with the general lighting.

To connect to emergency power systems in combination with INOTEC NEA-ICU via 2-core, non-shielded line.

Intended for the installation in luminaires.

With double occupancy terminals for the power supply. Suitable for units acc. to EN 50171/EN 50172.

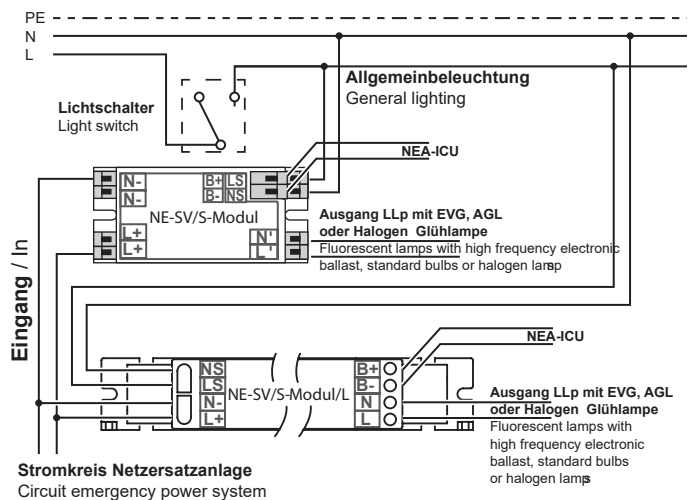

### Technical data

<b>Housing material:</b>	Thermoplastic V0
<b>Nominal voltage:</b>	230V AC 50Hz / 60Hz 176V - 264V DC
<b>Connectable load:</b>	5W - 120W
<b>Inrush current of the monitored luminaire:</b>	max. 80A / 500µs
<b>Amb. temp. range:</b>	-15 °C ... +50 °C
<b>EMC protection:</b>	acc. to EN 55015
<b>Conductor connection:</b>	2.5mm <sup>2</sup> single core or 1.5mm <sup>2</sup> braid wire with cable sleeve

### Technical data

<b>Housing material:</b>	Thermoplastic V0
<b>Nominal voltage:</b>	230V AC 50Hz / 60Hz 176V - 264V DC
<b>Connectable load:</b>	18W - 120W
<b>Inrush current of the monitored luminaire:</b>	max. 80A / 500µs
<b>Amb. temp. range:</b>	-15 °C ... +50 °C
<b>EMC protection:</b>	acc. to EN 55015
<b>Conductor connection:</b>	2.5mm <sup>2</sup> single core or 1.5mm <sup>2</sup> braid wire with cable sleeve

### NE-SV/S-Modul

Art. No. 851 006

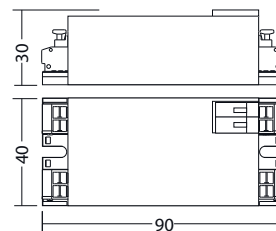

### Individual luminaire monitoring module



### NE-SV/S-Modul/L

Art. No. 851 034

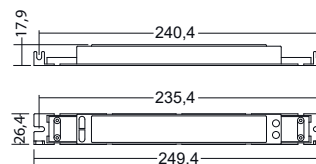

### Individual luminaire monitoring module



Electronical ballast for the operation and single monitoring of fluorescent lamps and compact fluorescent lamps TL/TC/TCD-EL, with address switch for luminaire coding.

Switch off in case of a defective luminaire.

To connect to emergency power systems via 2-core, non-shielded line. Intended for the installation in luminaires.

With double occupancy terminals for the power supply.

Suitable for units acc. to EN 50171/ EN 50172.

#### Technical data

<b>Housing material:</b>	Thermoplastic V0
<b>Nominal voltage:</b>	230V AC 50Hz /60Hz 176V - 264V DC
<b>Connectable load:</b>	6W - 13W
<b>Inrush current:</b>	7A / 100 $\mu$ s
<b>Amb. temp. range:</b>	-15 °C ... +50 °C
<b>EMC protection:</b>	acc. to EN 55015
<b>Conductor connection:</b>	2.5mm <sup>2</sup> single core or 1.5mm <sup>2</sup> braid wire with cable sleeve

#### Technical data

<b>Housing material:</b>	Thermoplastic V0
<b>Nominal voltage:</b>	230V AC 50Hz /60Hz 176V - 264V DC
<b>Connectable load:</b>	4W - 6W
<b>Inrush current:</b>	7A / 100 $\mu$ s
<b>Amb. temp. range:</b>	-15 °C ...+50 °C
<b>EMC protection:</b>	acc. to EN 55015
<b>Conductor connection:</b>	2.5mm <sup>2</sup> single core or 1.5mm <sup>2</sup> braid wire with cable sleeve

#### NE-SV-EVG 6-13

Art. No. 860 006

#### Electronic ballast

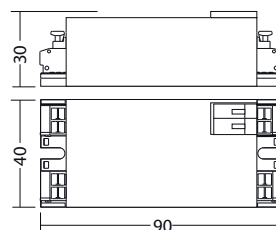

#### NE-SV-EVG 4-6

Art. No. 860 028

#### Electronic ballast

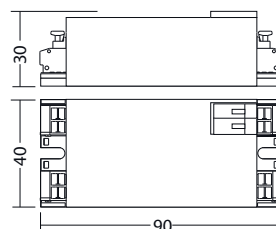

The MTB-remote mimic panel (MTB/AP = wall mounting, MTB/UP = switch panel-/ recessed wall mounting) used for the external status- and failure display. Additionally the remote mimic panel enables the blocking of the luminaires, which are connected to the NEA-ICU, via integrated key switch.

Function display:

- green LED - normal operation
- yellow LED - battery mode (emergency operation)
- red LED - failure (sum failure)

Operating mode : continuous operation

### Technical data

<b>Housing material:</b>	Stainless steel cover /polycarbonate
<b>Nominal voltage:</b>	24V DC $\pm$ 10 %,
<b>Protection class:</b>	III
<b>Protection category:</b>	IP 30
<b>Amb. temp. range:</b>	-20°C ... +40°C
<b>EMC protection:</b>	acc. to EN 55015
<b>Conductor connection</b>	2.5mm <sup>2</sup> single core or 1.5mm <sup>2</sup> braid wire with cable sleeve
<b>Max. cable length for 0.5mm<sup>2</sup>:</b>	500m
<b>Operation mode:</b>	Continuous operation

### MTB / AP

Art. No. 990 097

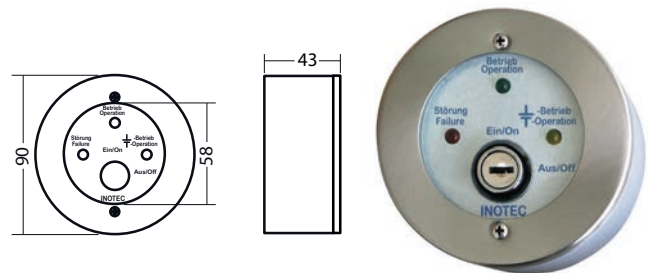

### MTB / UP

Art. No. 990 039

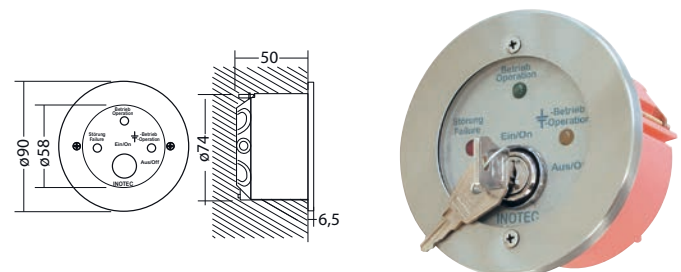



INOTEC Sicherheitstechnik GmbH  
Am Buschgarten 17  
59469 Ense

Tel +49 2938 9730 -0

Fax +49 2938 9730 -29

[info@inotec-licht.de](mailto:info@inotec-licht.de)

[www.inotec-licht.de](http://www.inotec-licht.de)

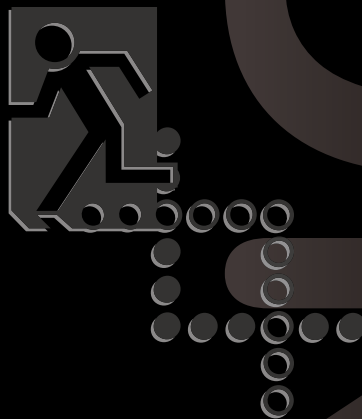

**INOTEC**  
Sicherheitstechnik GmbH